



aspoeck.com

# FLEXLED PROFILES

FÜR DIE MONTAGE VON FLEXLED  
MEDIUM BÄNDERN

FOR THE MOUNTING OF FLEXLED  
MEDIUM STRIPS



**A.PIERINGER GmbH**

**www.ap.works**

2141 Ameis, Obere Hauptstraße 68

Telefon: +43 / 2425 / 278 00

E-Mail: vk@ap.co.at

# PRODUCT INFO

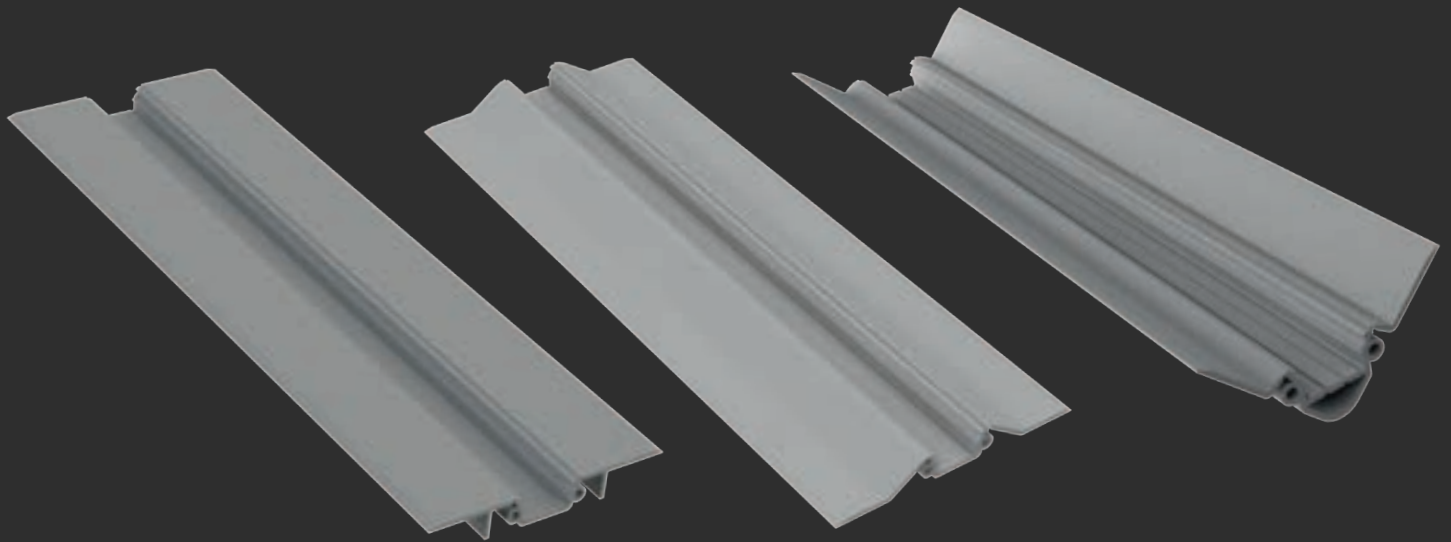



## FLEXLED - PROFILES

FÜR DIE PROFESSIONELLE MONTAGE VON FLEXLED MEDIUM BÄNDERN  
FOR A PROFESSIONAL MOUNTING OF FLEXLED MEDIUM STRIPS

FLAT

RAMP

CORNER 45°

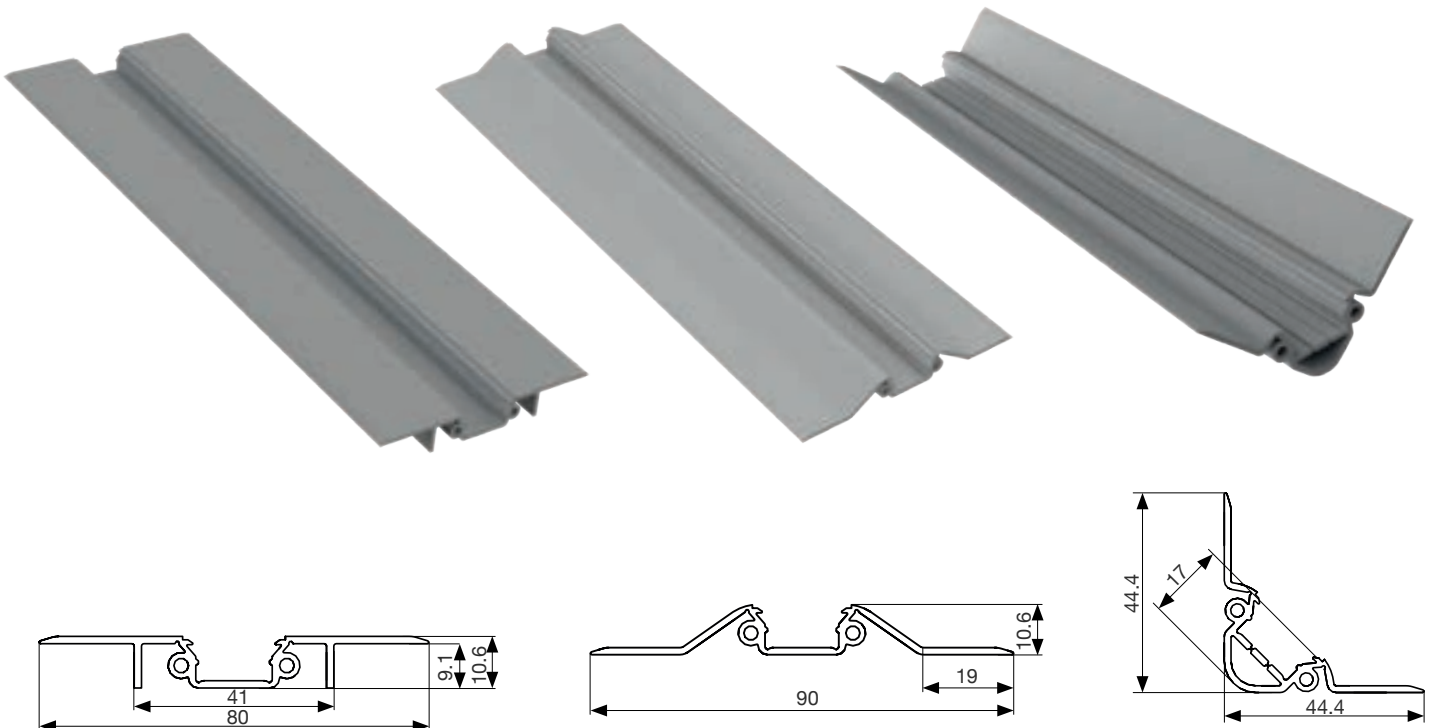

## FEATURES

**EINFACHE MONTAGE**  
EASY MOUNTING

**IM INNEN- & AUSSENBEREICH ANWENDBAR**  
CAN BE USED INDOORS & OUTDOORS







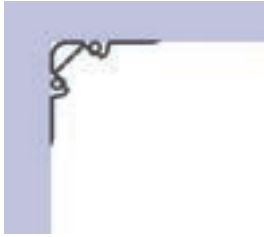

**PROFILE IN SCHWARZ UND LICHTGRAU ERHÄLTlich FÜR EINEN UNAUFFÄLLIGEN ANBAU**  
PROFILES AVAILABLE IN BLACK AND LIGHT GREY FOR INCONSPICUOUS INSTALLATION

**FLÄCHENBÜNDIGER EINBAU MÖGLICH (BEI FLAT PROFIL)**  
FLUSH MOUNTING POSSIBLE (FOR PLAT PROFILE)

**MIT VORSPANNUNG EXTRUDIERT, UM SICH PERFEKT INS ECK EINZUFÜGEN (BEI CORNER PROFIL)**  
EXTRUDED WITH PRELOAD TO FIT PERFECTLY INTO THE CORNER (FOR CORNER PROFILE)





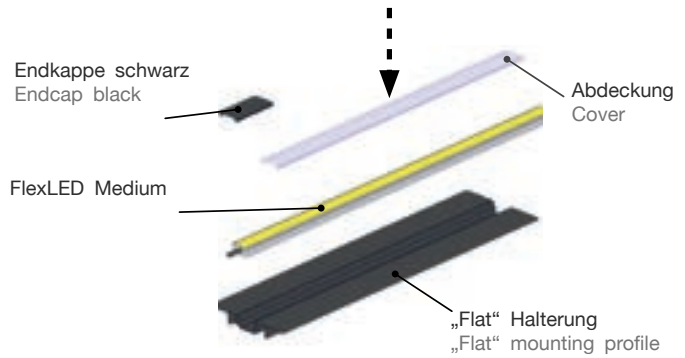

TECHNISCHE DATEN TECHNICAL FACTS	
VIBRATIONSGEPRÜFT: VIBRATION TESTED:	Aspöck Systems Vibrationstest (PAW 80.04) Aspöck Systems vibration test (PAW 80.04)
UV-STABILITÄT: UV STABILITY:	2000 Stunden 2000 hours
MATERIAL: MATERIAL:	PVC
ARBEITSTEMPERATURBEREICH: WORKING TEMPERATURE RANGE:	-20°C - +50°C
LAGERTEMPERATURBEREICH: STORAGE TEMPERATURE RANGE:	-40°C - +80°C
CHEMISCHE BESTÄNDIGKEIT: CHEMICAL RESISTANCE:	Diesel, bleifreies Benzin, Isopropylalkohol-Reiniger, Motoröl, Auto-/Lkw-Waschchemikalien Diesel, unleaded gasoline, isopropyl alcohol cleaner, motor oil, car/truck wash chemicals

ANWENDUNGSBEISPIELE APPLICATION EXAMPLES			
CORNER 45°			
FLAT			
RAMP			

# PRODUCT INFO



BESCHREIBUNG DESCRIPTION	OEM
 <p>Mounting Profile - Medium Cover 1,0 m In Kombination mit IP66 oder nicht vergossenen Bändern notwendig Necessary in combination with IP66 or non-encapsulated strips</p> <p>transparent diffuse</p>	<p>15-5250-737 15-5250-747</p>
 <p>Mounting Profile - Medium Endcap 1,0 m Zur Abdeckung von Blindbereichen / For covering blind areas</p> <p>grey RAL 7035 black RAL 9005</p>	<p>15-5250-757 15-5250-767</p>
 <p>Mounting Profile - Medium Ramp 1,0 m</p> <p>grey RAL 7035 black RAL 9005</p>	<p>14-4230-657 14-4230-627</p>
 <p>Mounting Profile - Medium Flat 1,0 m</p> <p>grey RAL 7035 black RAL 9005</p>	<p>14-4230-667 14-4230-637</p>
 <p>Mounting Profile - Medium Corner 45° 1,0 m</p> <p>grey RAL 7035 black RAL 9005</p>	<p>14-4230-677 14-4130-647</p>

Sonderlängen auf Anfrage.  
Special lengths on request.

product information\_FlexLED\_Profiles\_V2 | 2024-07  
Misprints, technical changes and illustrations are subject to change.  
© Aspöck Systems GmbH

Non-compliance with the information given (e.g. temperature) results in the exclusion of warranty/liability. For details, see the mounting instructions/TSD [www.aspoeck.com](http://www.aspoeck.com).